

**SAMPLE PROJECT**  
**SOMEWHERE, USA**

Issue Dates

Copyright 2017

**SAMPLE PROJECT  
SOMEWHERE, USA**

Issue Dates

Copyright 2017

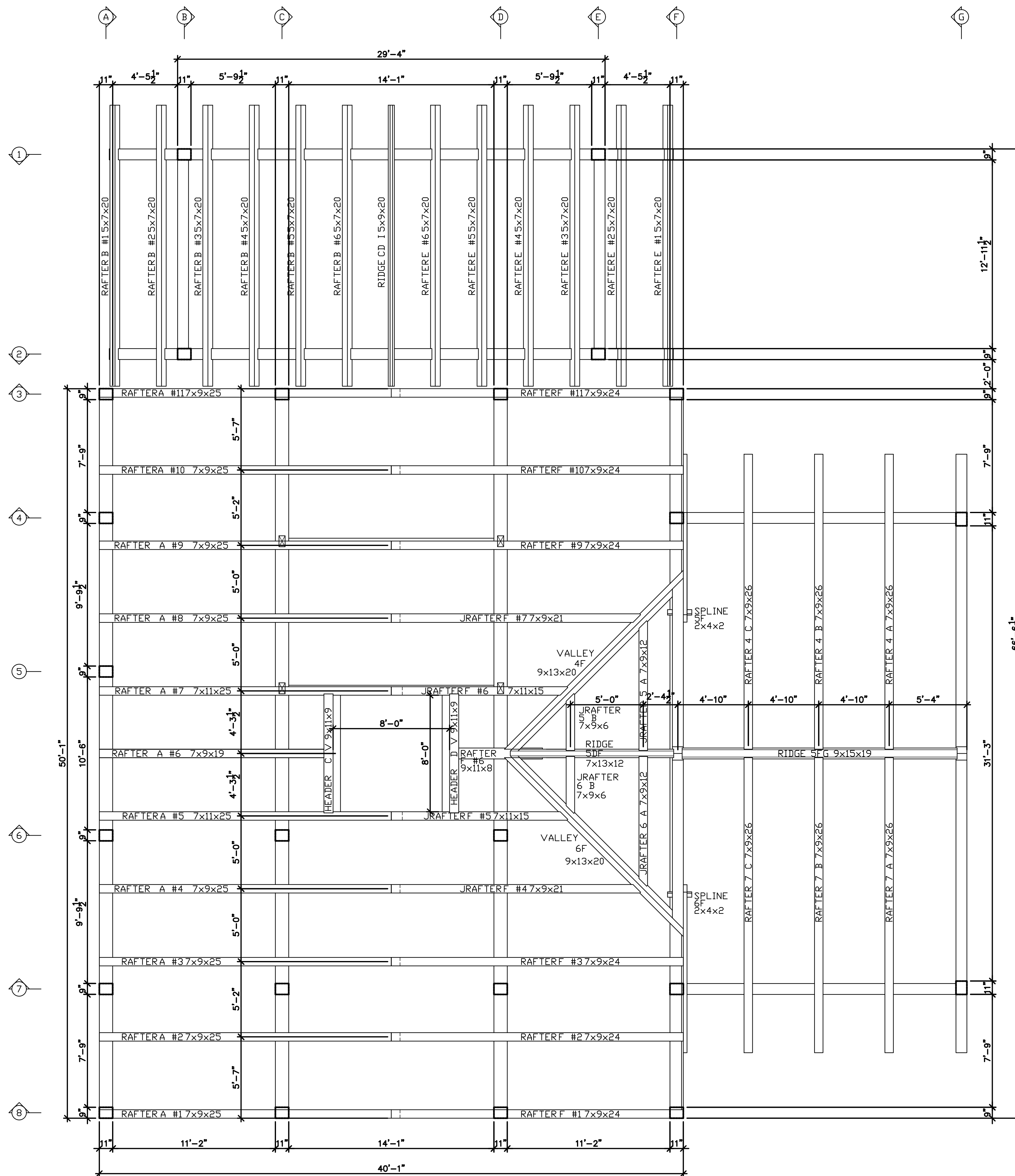

POST & RAFTER PLAN

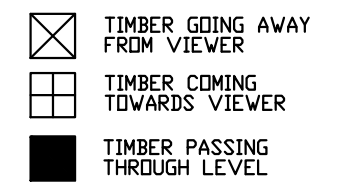
**LEGEND**  
  
 □ TIMBER GOING AWAY FROM VIEWER  
 ▤ TIMBER COMING TOWARDS VIEWER  
 ■ TIMBER PASSING THROUGH LEVEL

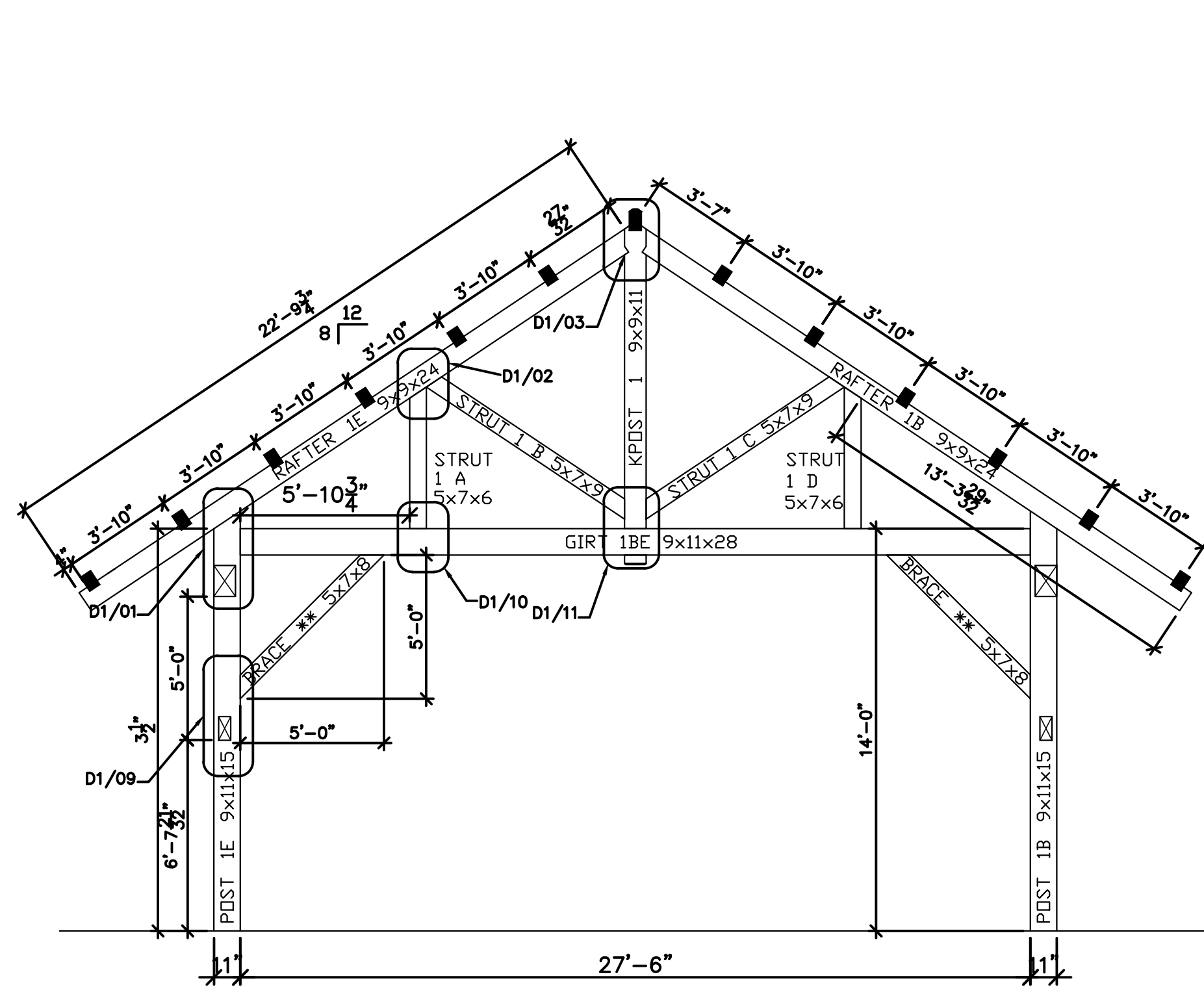

BENT 1

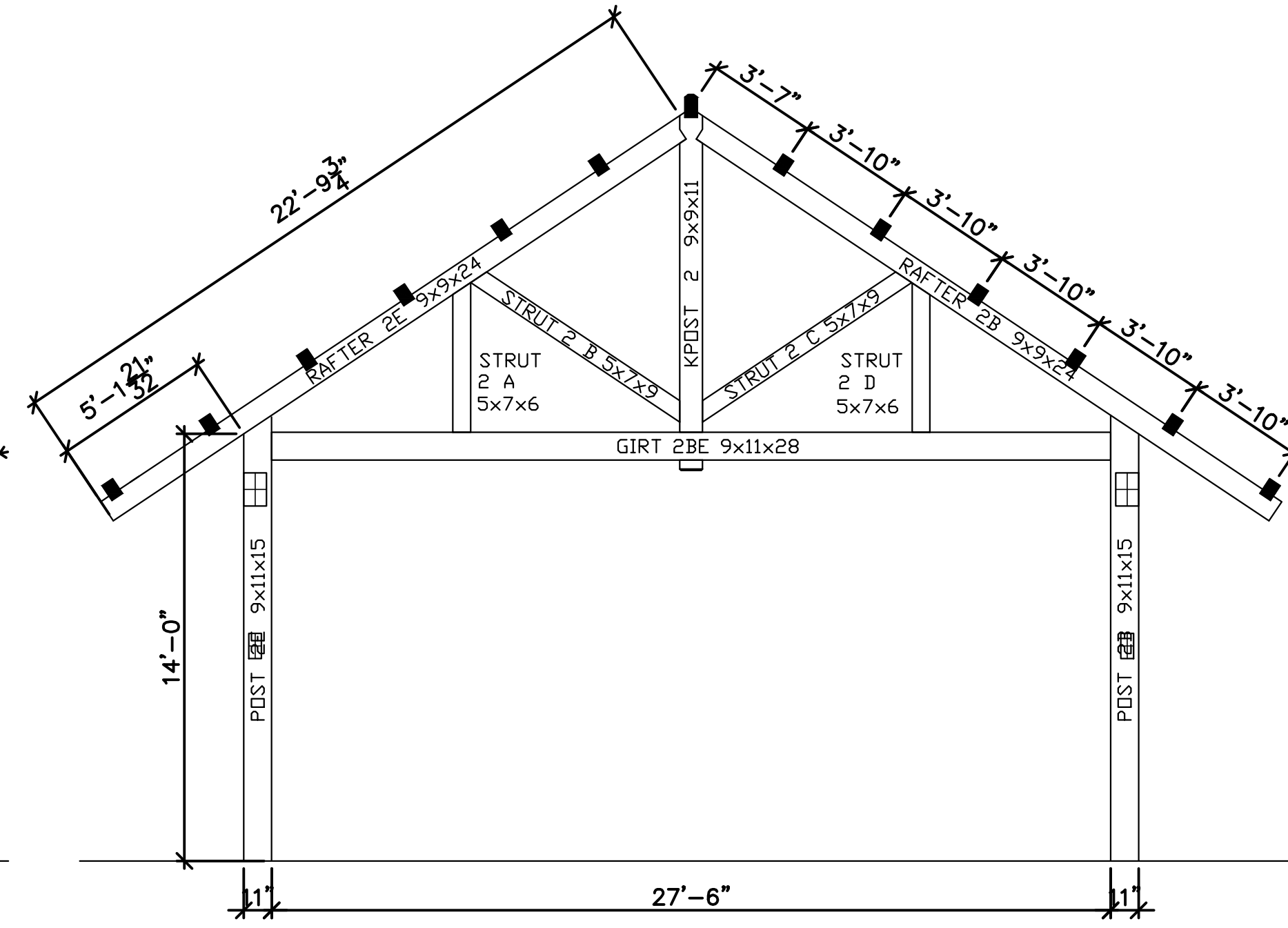

BENT 2

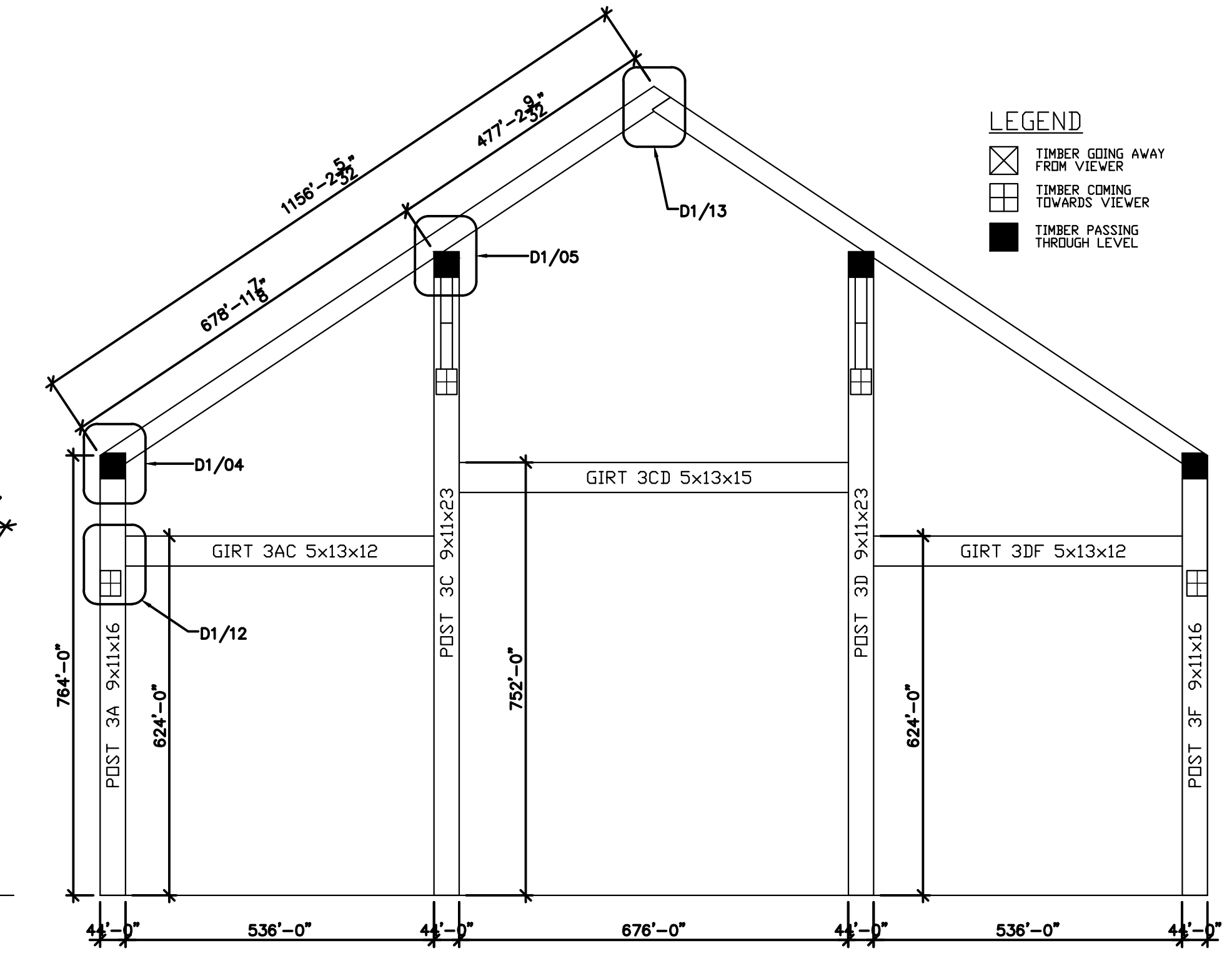

BENT 3

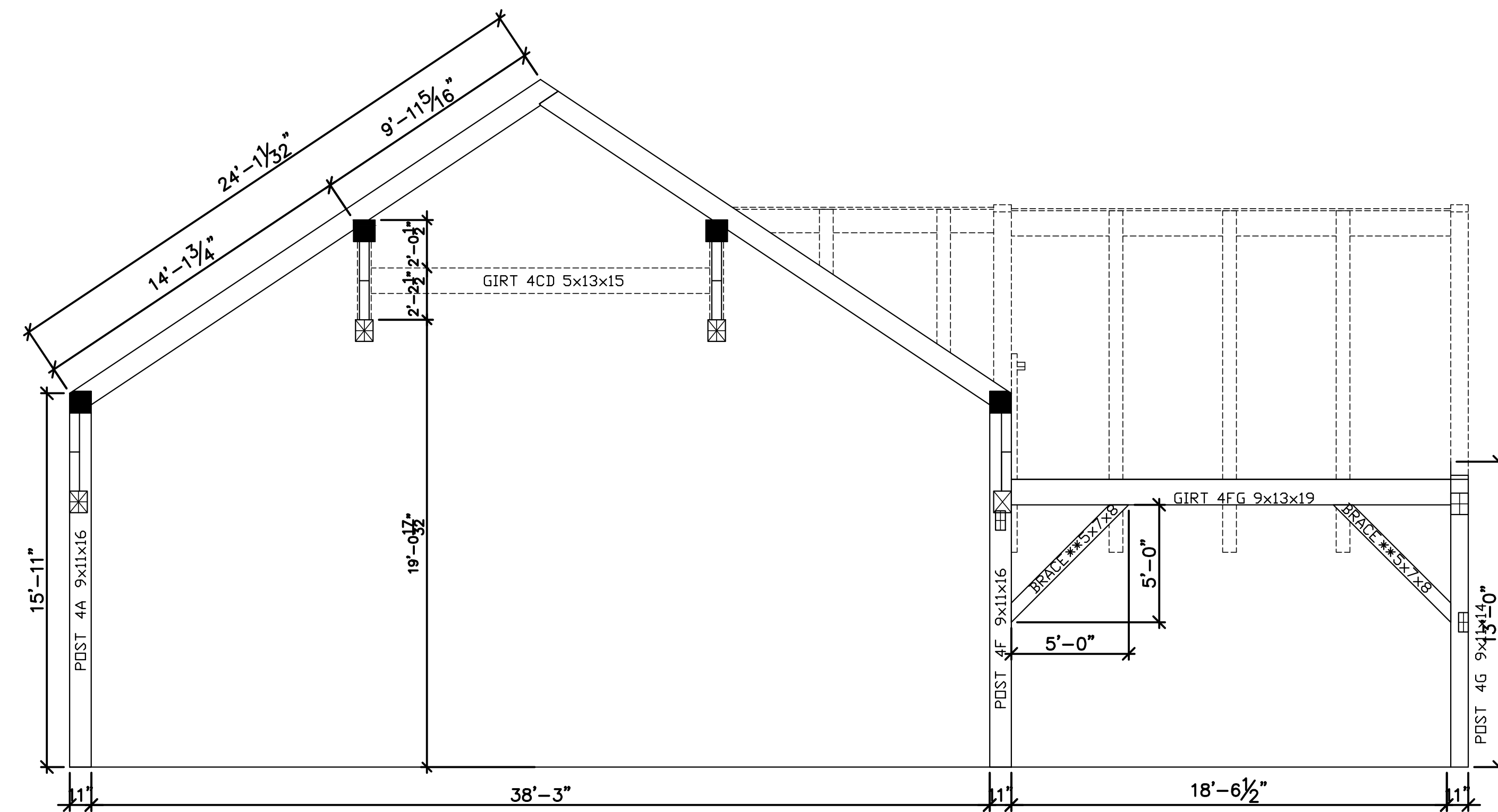

BENT 4

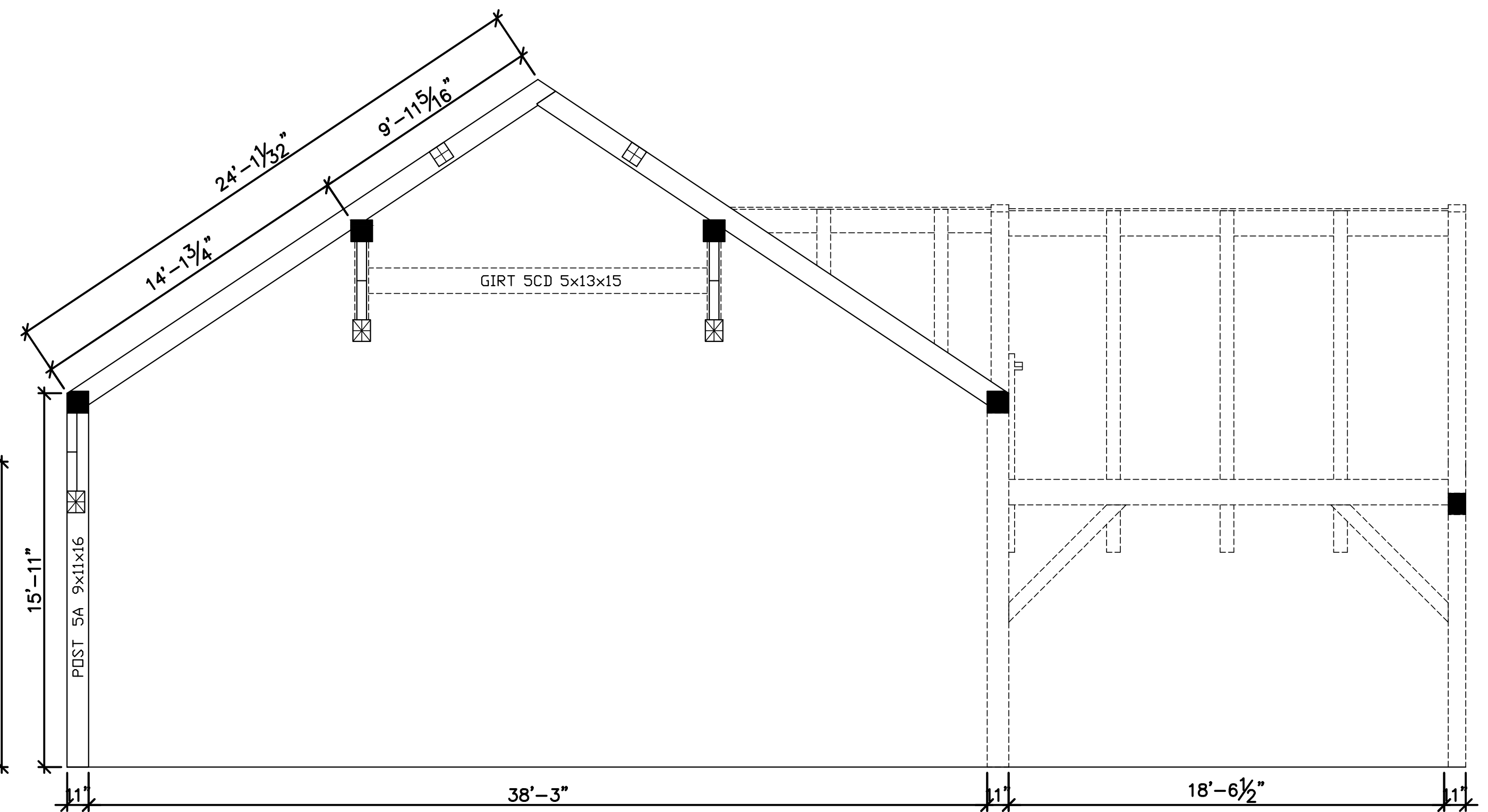

BENT 5

**SAMPLE PROJECT**  
**SOMEWHERE, USA**

Issue Dates

Copyright 2017

LEGEND

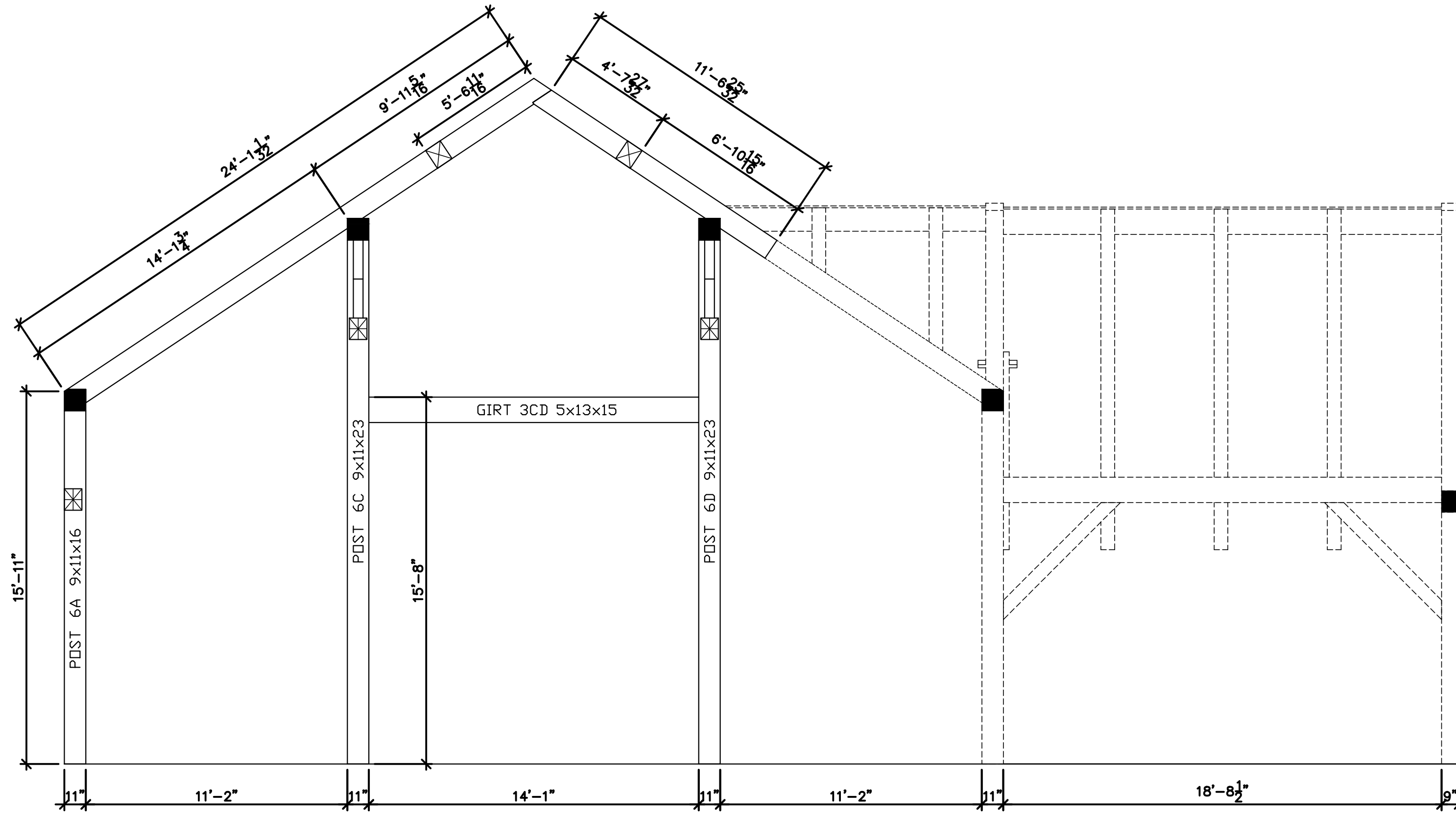

BENT 6

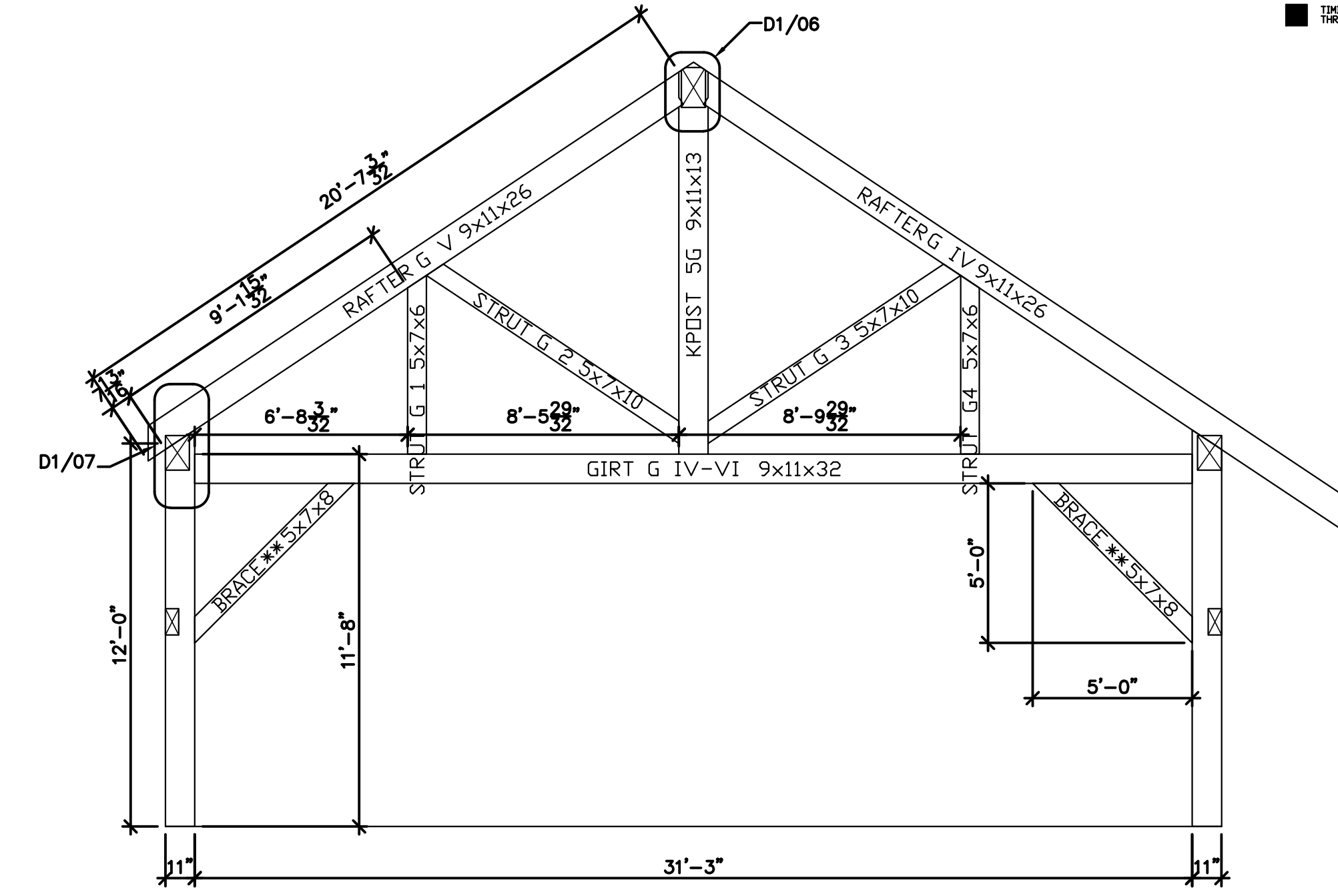

WALL G

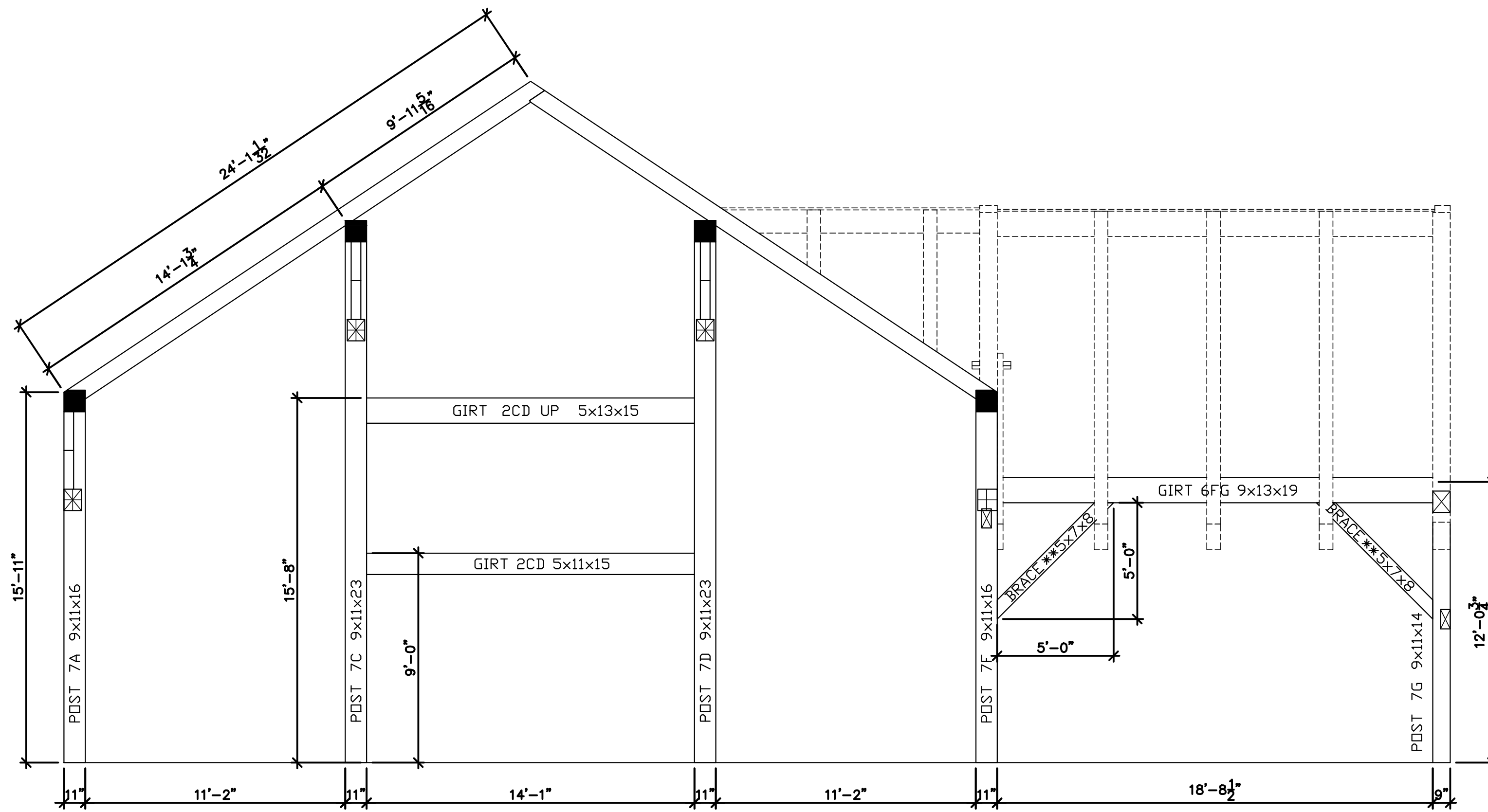

BENT 7

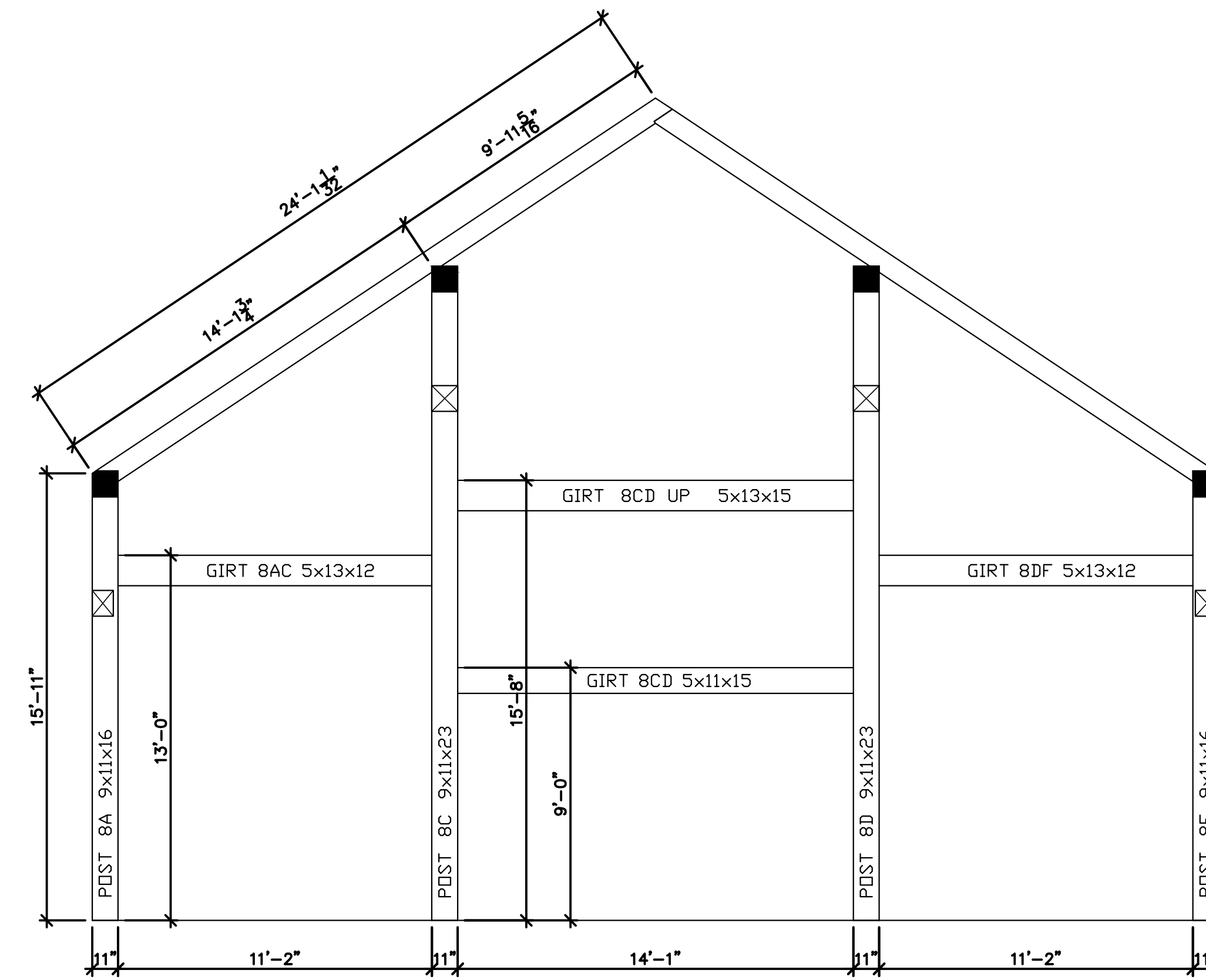

BENT 8

**SAMPLE PROJECT  
SOMEWHERE, USA**

Issue Dates

Copyright 2017

LEGEND  
[Symbol] TRUSS GIRTS AWAY  
[Symbol] TRUSS CHAINS  
[Symbol] TRUSS CHAINS  
[Symbol] TRUSS CHAINS

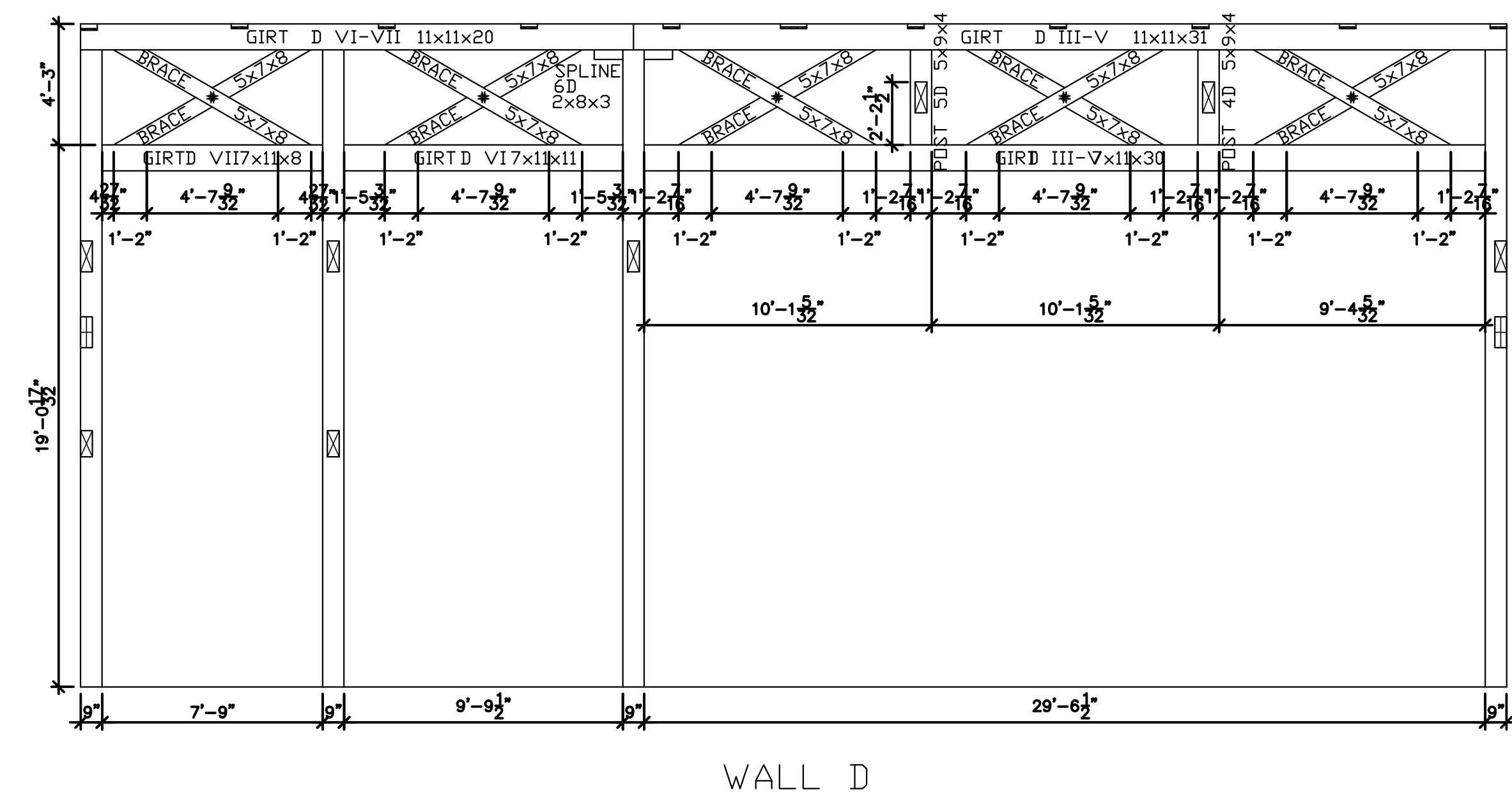
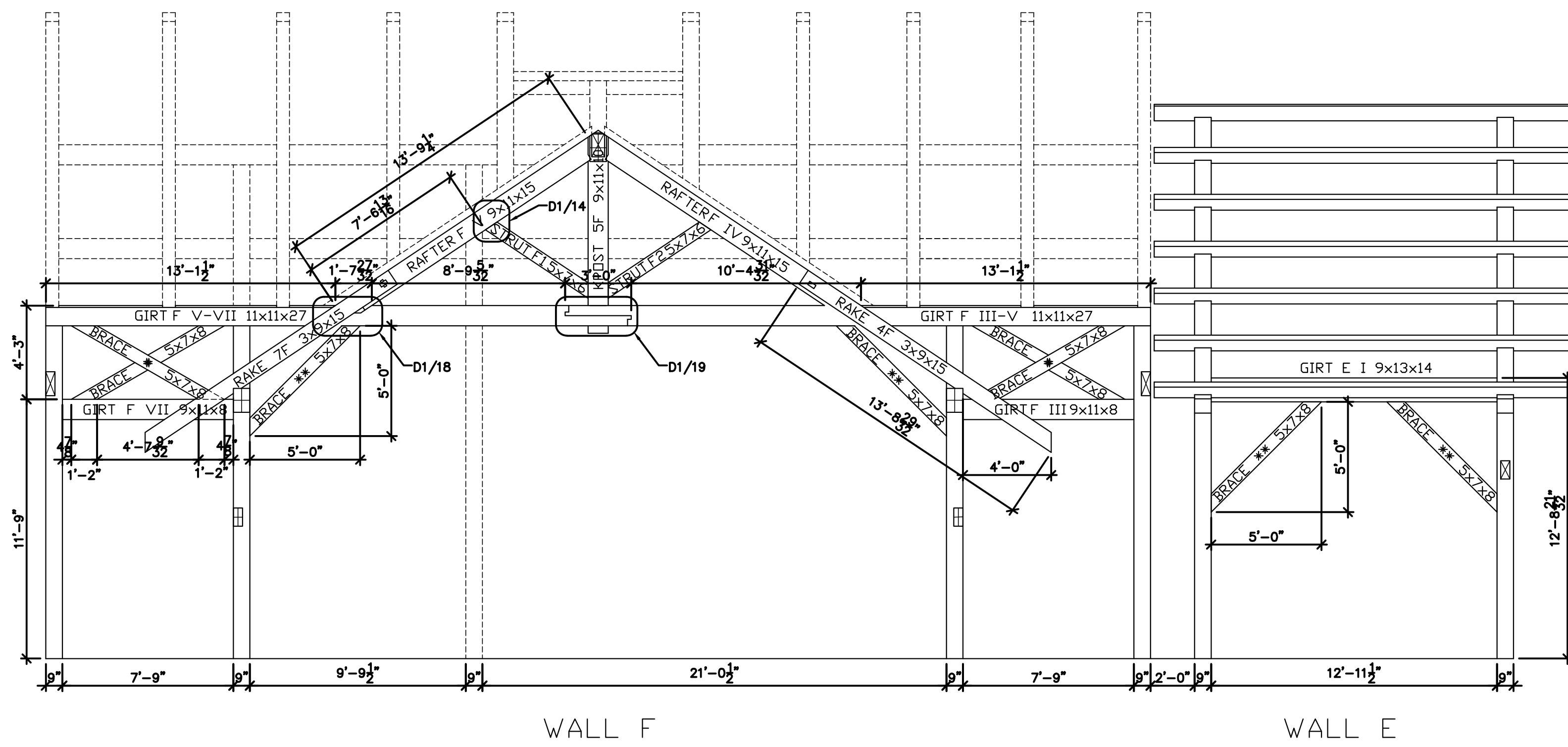
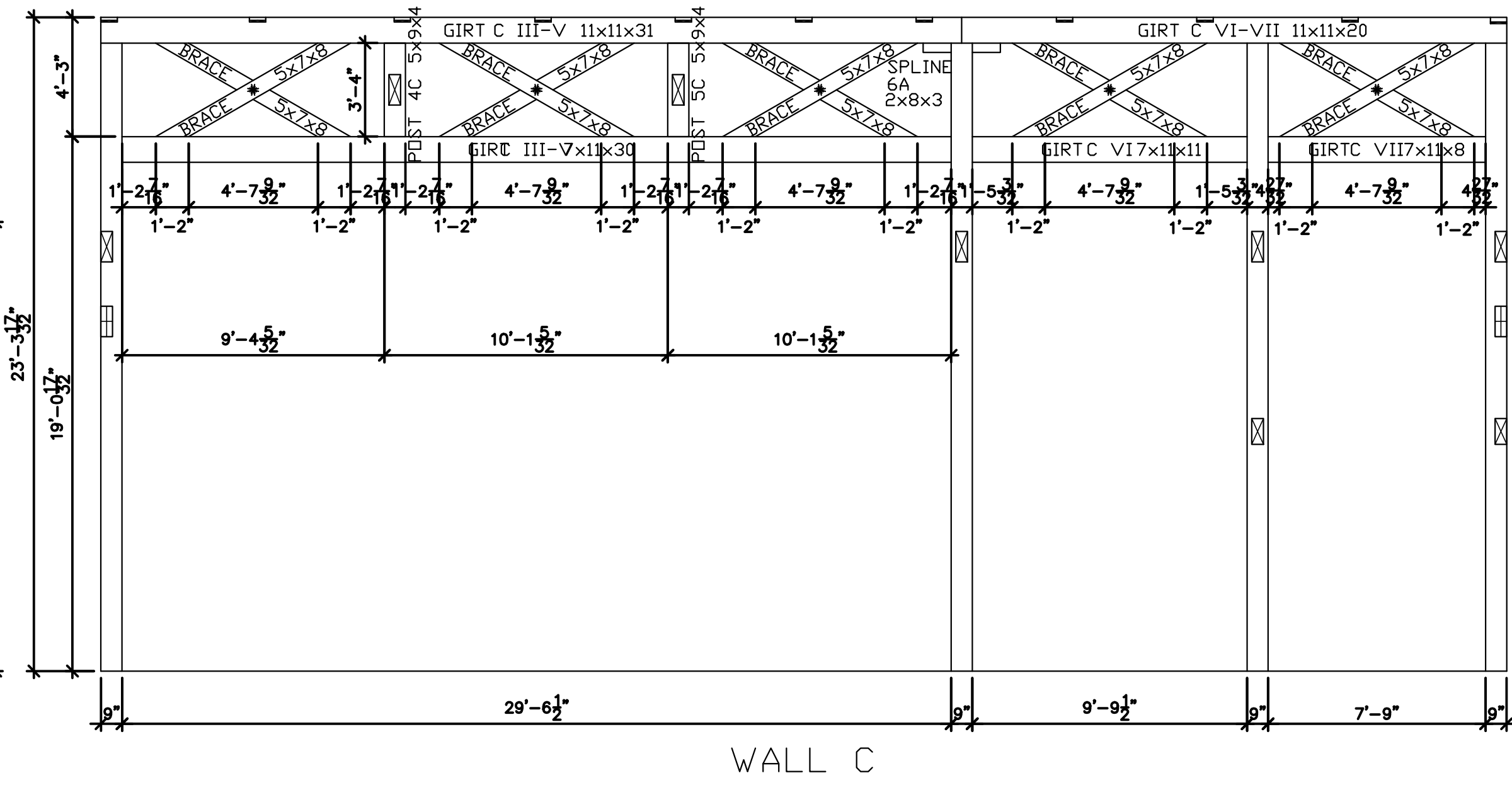
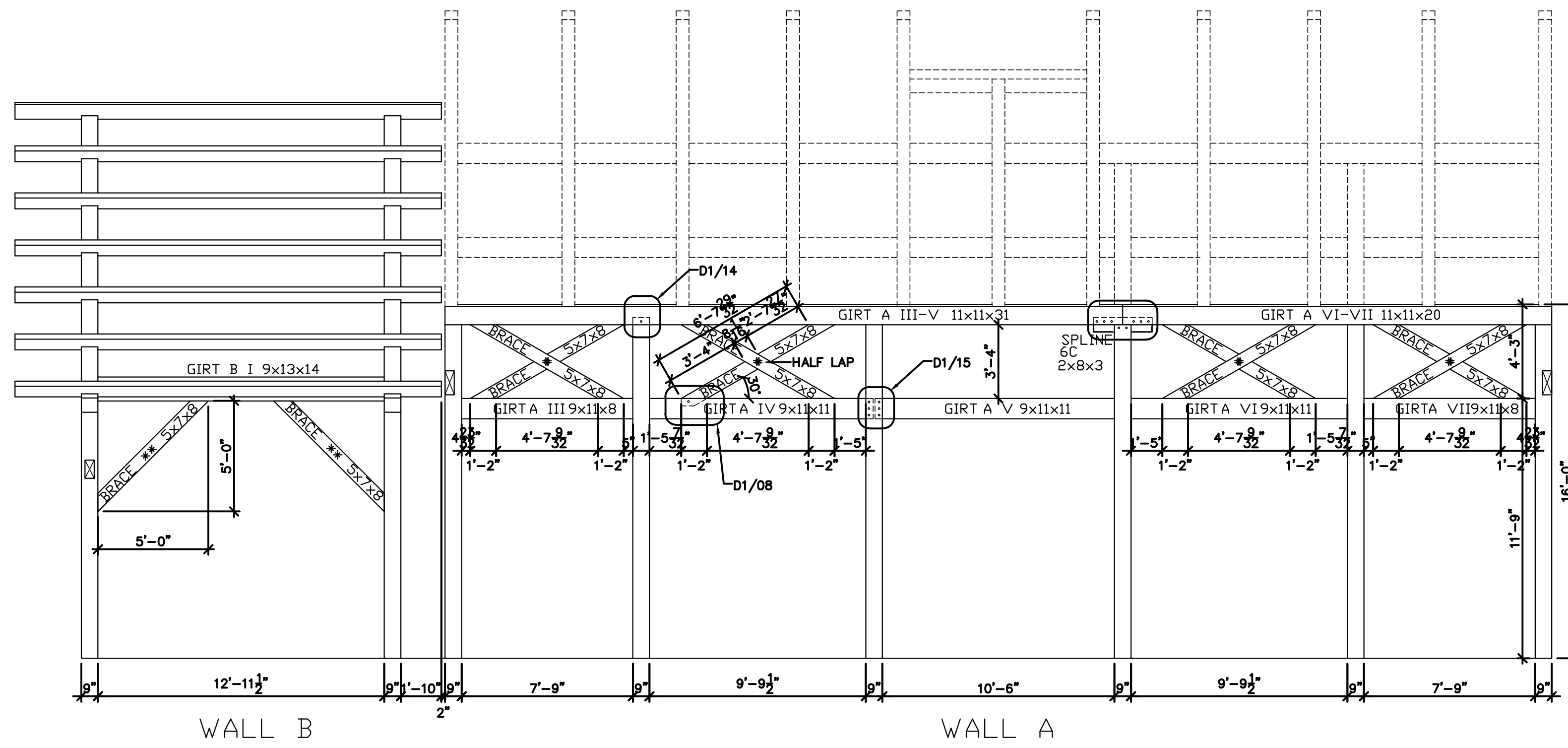

SAMPLE PROJECT  
SOMEWHERE, USA

Issue Dates

Copyright 2017

**SAMPLE PROJECT  
SOMEWHERE, USA**

Issue Dates

Copyright 2017

